

# IDP Inc. FIXED THROAT FRAME SECTIONS

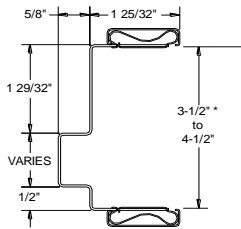

**I** 1-3/4" FRAME  
DOUBLE RABBET

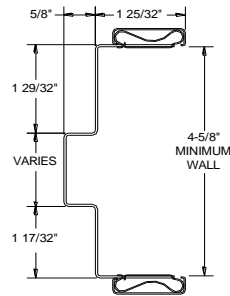

**II** 1-3/4" FRAME  
SINGLE RABBET

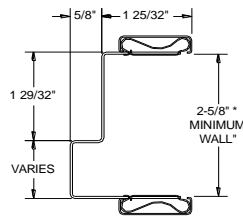

**III** 1-3/4" x 1-3/4"  
COMMUNICATING  
FRAME

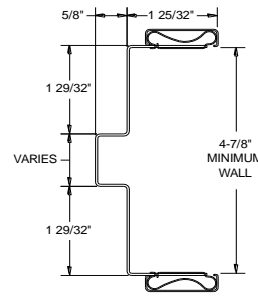

**IV** 1-3/4" KERF FRAME  
(KF SERIES)

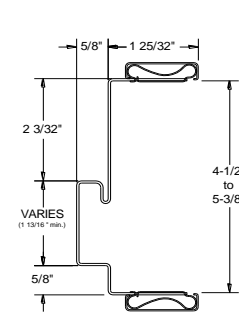

**V** 1-3/8" FRAME  
DOUBLE RABBET

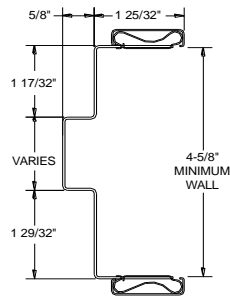

**VI** 1-3/8" FRAME  
SINGLE RABBET

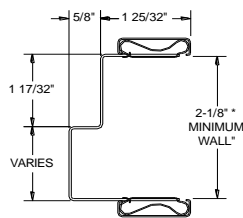

**VII** 1-3/4" x 1-3/8"  
COMMUNICATING  
FRAME

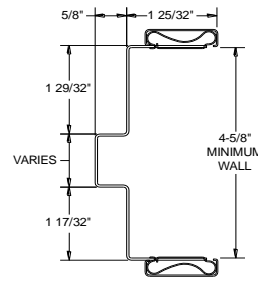

**VIII** HEADER &  
POCKET UPRIGHT

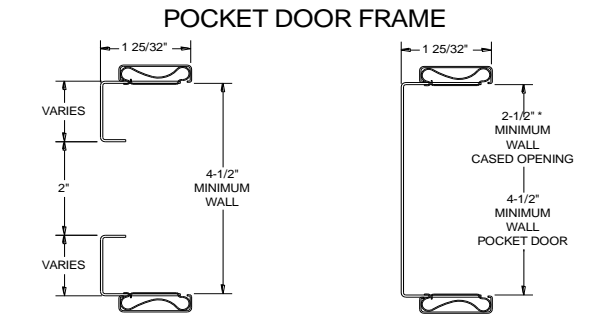

**IX** CASED OPENING or  
POCKET DOOR  
STRIKE UPRIGHT

\* MINIMUM WALL SIZE FOR FIRE RATED FRAMES IS 4-1/2"



**IDP Inc.**  
21300 W. 8 Mile Rd.  
Southfield, MI 48075

Phone: 248-352-044  
Fax: 248-352-4222  
www.idpframes.com

PROJECT:

JOB NO.

SHEET:

OF: